

# User Manual

for Kinetic Wall Switches

CUL 40031

CUL 40032

CUL 40033

CUL 40034

CUL 40035

CUL 40036

## A. What is in the box ?

1 Gang:

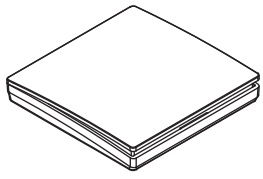

x 1

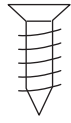

x 2



x 2

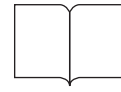

x 1

or 2 Gang:

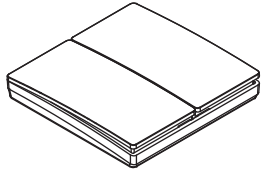

x 1

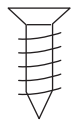

x 2



x 2

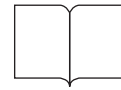

x 1

or 3 Gang:

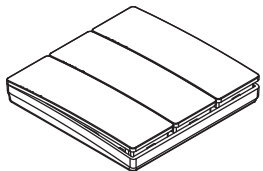

x 1

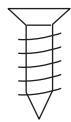

x 2



x 2

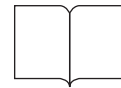

x 1

## B. Specifications

**Dimensions:**

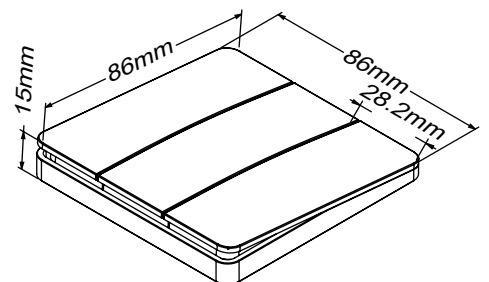
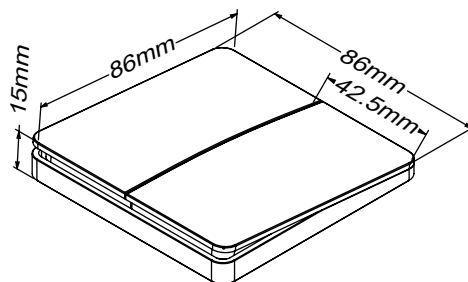
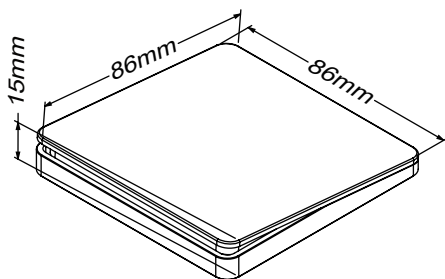

**Power Source:**

Self Powered (Kinetic)

**Radio Frequency:**

433 MHz

**Switching Type:**

Push Switch

**Dimming Type:**

Push Selected

Only available on 2 Gang Switch

**IP Rating:**

IP42

**Body Material:**

Polycarbonate

**Transmission Range:**

Outdoor 150m (no barrier)

Indoor 25m (plaster board; drywall)

Indoor 12m (concret, glass walls)

(Range may vary depending on surrounding situation)



CE RoHS



# C. Installations

## 1. Screw Installation

(a) Remove front cover;

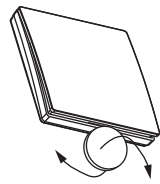
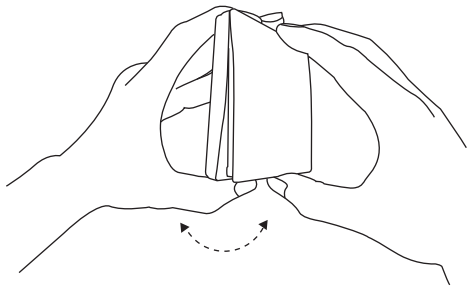

Inserting a coin into the switch gap and twisting it, can help to open the cover.

(b) Fix to back box;

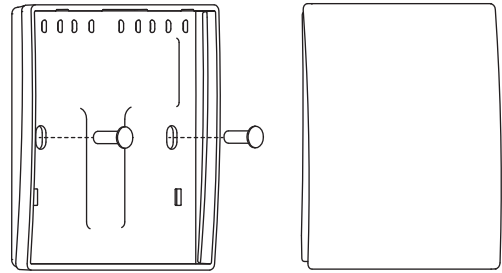

(c) Reinstall front cover;

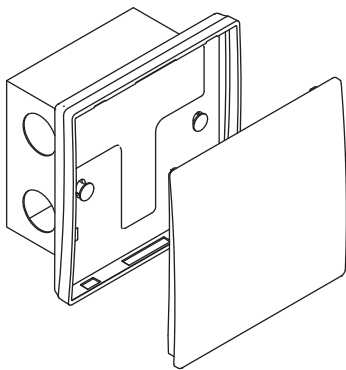

(d) Installation Completed.

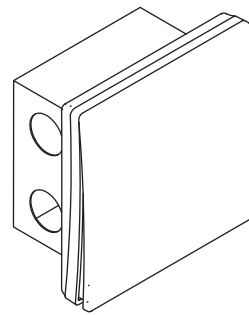

## 2. Surface Installation

(a) Remove sticker cover;

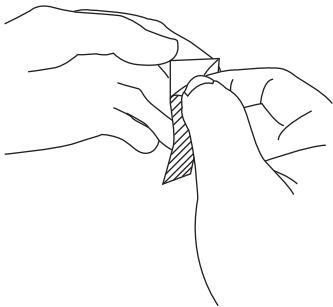

(b) Apply to the switch;

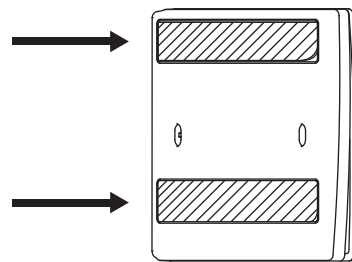

(c) Clean the surface

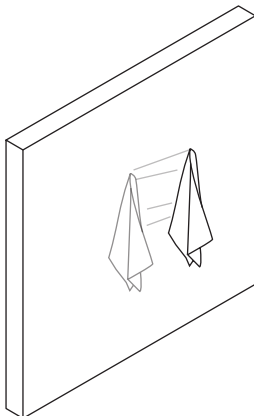

(d) Attach the switch to surface.

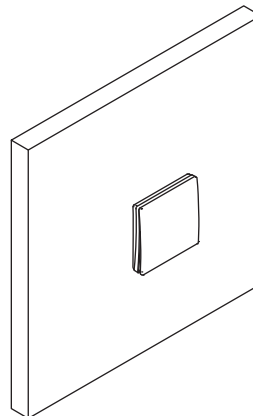

## D. Operation

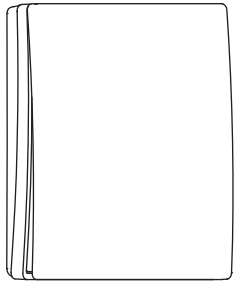

1 Gang



2 Gang



3 Gang

I/O ON / OFF Switch

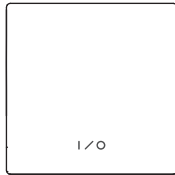

1 Zone

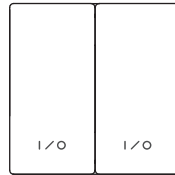

2 Zone

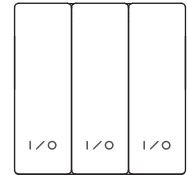

3 Zone

Dimmer Switch



1 Zone

CCT Switch

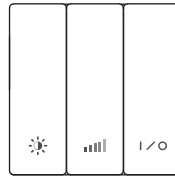

1 Zone

RGB Switch

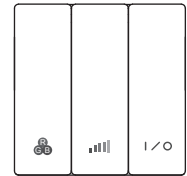

1 Zone

## E. Compatible controllers (Order seperately.)

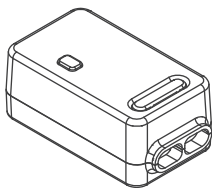

ON / OFF Receiver

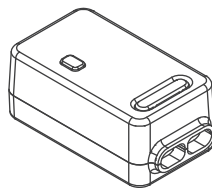

ON / OFF Receiver  
Tuya Wifi (2.4G)

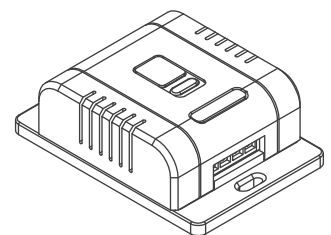

Dimmer Receiver  
Tuya Wifi (2.4G)