

DOOR DETECTOR G5 SERIES

WITH POWER SUPPLY

USER MANUAL

WECO
Version UM.G5.PWS



INSTALLATION INSTRUCTIONS

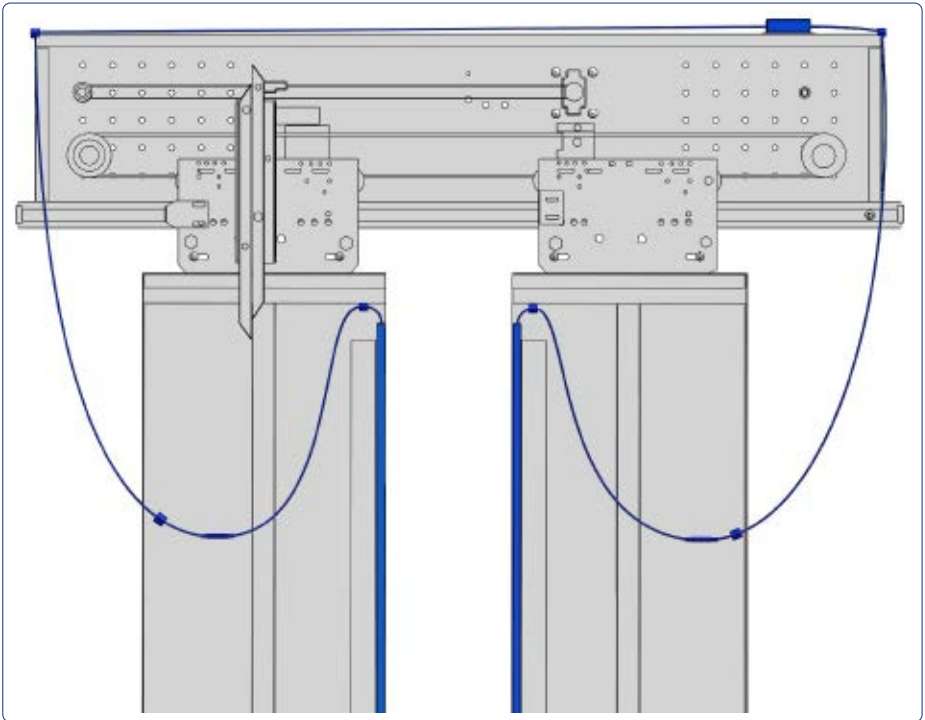

1. Securely fix the transmitter and receiver to the car/car doors through the fixing holes with the bolts provided, ensuring that the labels are pointing outwards.
2. Ensure that both the receiver and the transmitter are at the same level.
3. Fix the power supply on the car top. Ensure that the steel cover is grounded.
4. Connect the power supply to the input terminals. Connect the output signals to the output terminals.
5. Connect the cables from the receiver and the transmitter to the input terminals of the door controller. Ensure that both cables can be easily and smoothly bent. Tightly lock both sides of the intermediate connectors.
6. Switch on the power.
The yellow LED in the receiver will light up.
The red LED in the receiver is lit when the light beams are interrupted.



Please ask us about our range of fixings clips and brackets.



TROUBLESHOOTING

Neither LED in the receiver is lit.

→ The cable is broken or not connected.

Both the yellow and red LEDs of the door detector are lit without interruption between the RX and TX.

→ The plastic filter is too dirty.
→ Other infrared equipment is nearby.
The ambient light is stronger than allowed.
There is a system fault.

The LEDs of the door detector are lit correctly when interrupted, but the car door doesn't open.

→ Wrong connection with NC/NO contacts.
The output relay is broken.
Check the wiring.

The green LED in the power supply is not lit.

The power supply wires are broken or incorrectly connected.
The terminal connection is too loose.
→ The power supply is broken and needs to be replaced.

Power Supply LEDs

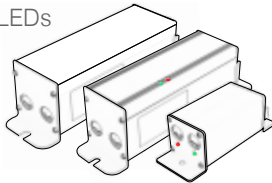

Door Detector LEDs



NOTES AND ADVICE

- Keep connection cables away from high voltage and/or high current wires.
- Keep connection cables away from door motor and door drive.
- Avoid direct sunlight or other infrared ingress to the receiver (RX).
- Prior to power-on, clean the lenses with a soft, damp cloth.
- Do not bend or twist the edges, and do not scratch the lenses.

PLANNED MAINTENANCE PROCEDURE

- Ensure that the yellow LED is lit (system functioning), then clean the lense with a soft, damp cloth.
- Check all plug and terminal connections.
- Perform a detection test by inserting an object greater than 50mm between the TX and RX.
- The red LED status indicator will light to confirm object detection.

POWER SUPPLY

03.G5.PWS.FED

MODEL	03.G5.PWS.FED.24
VOLTAGE	DC24V±20%,4W
MODEL	03.G5.PWS.FED.230
VOLTAGE	AC220V±15%,50/60Hz,4W

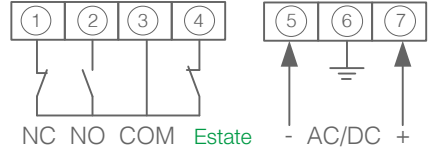

Buzzer Function

SW1	Buzzer functions	ON	Buzzer on	OFF	Buzzer off
SW2	Buzzer delay	ON	Delay 20s	OFF	Delay 30s
SW3	Buzzer active	ON	Infinite	OFF	60s
SW4	Buzzer setting	ON	Intermittent	OFF	Constant

03.G5.PWS.FD2

MODEL	03.G5.PWS.FD2.24
VOLTAGE	DC24V±20%,4W
MODEL	03.G5.PWS.FD2.230
VOLTAGE	AC220V±15%,50/60Hz,4W

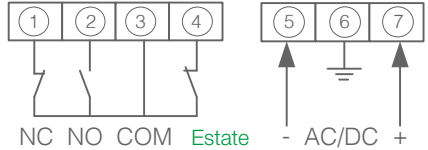

03.G5.PWS.XN5

MODEL	03.G5.PWS.XN5.230
VOLTAGE	AC220V±15%,50/60Hz,3W

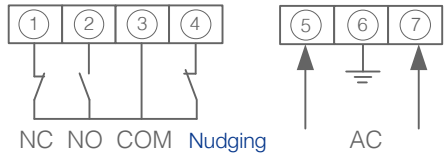

Buzzer Function

SW1	Buzzer functions	ON	Buzzer on	OFF	Buzzer off
SW2	Buzzer delay	ON	Delay 20s	OFF	Delay 30s
SW3	Buzzer active	ON	Infinite	OFF	60s
SW4	Buzzer setting	ON	Intermittent	OFF	Constant

POWER SUPPLY

03.G5.PWS.FED.DC3

MODEL	03.G5.PWS.DC3.24
VOLTAGE	15VDC - 30VDC,3w

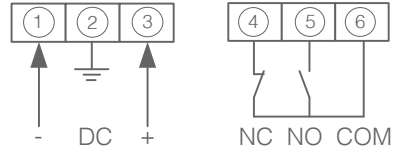

03.G5.PWS.KAP

MODEL	03.G5.PWS.KAP.110
VOLTAGE	AC110V±15%,50/60Hz,3W
MODEL	03.G5.PWS.KAP.230
VOLTAGE	AC220V±15%,50/60Hz,3W

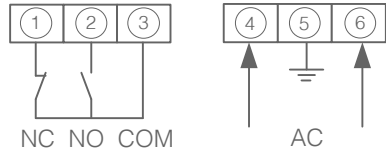

WARNING



- This equipment should be installed by qualified technicians.
- Follow the instructions of this manual.
- Do not drill the PCB.

PACKING LIST



Please check if anything is missing from the packing list. Contents may slightly according to the customers specific requirements.

Power supply	1 piece
Cables	2 cable
Transmitter (TX)	1 piece
Receiver (RX)	1 piece
Operation manual	1 copy
Mounting accessories	1 set