

Dimensions

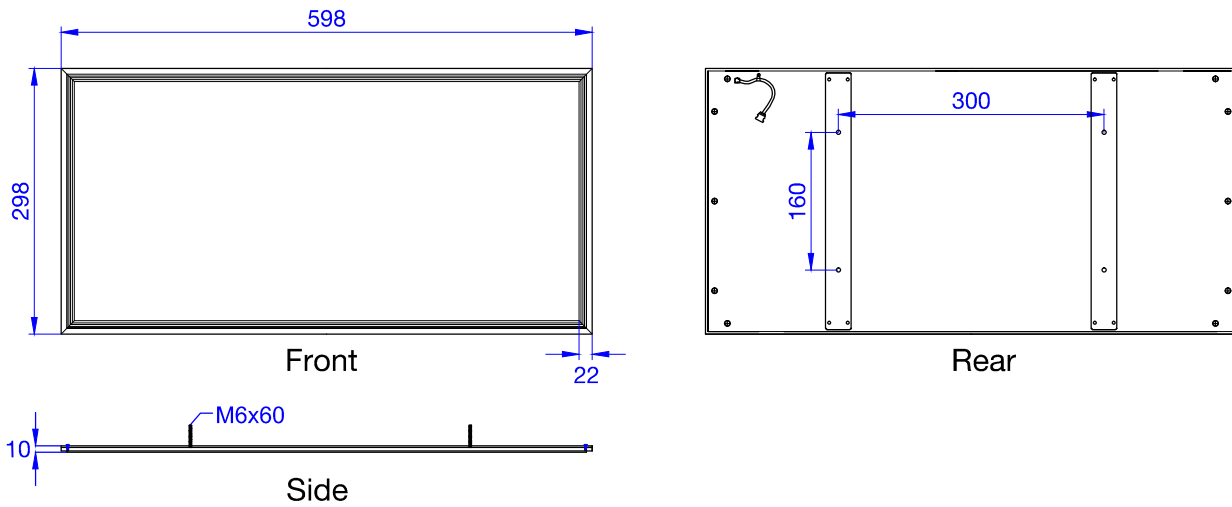

Installation

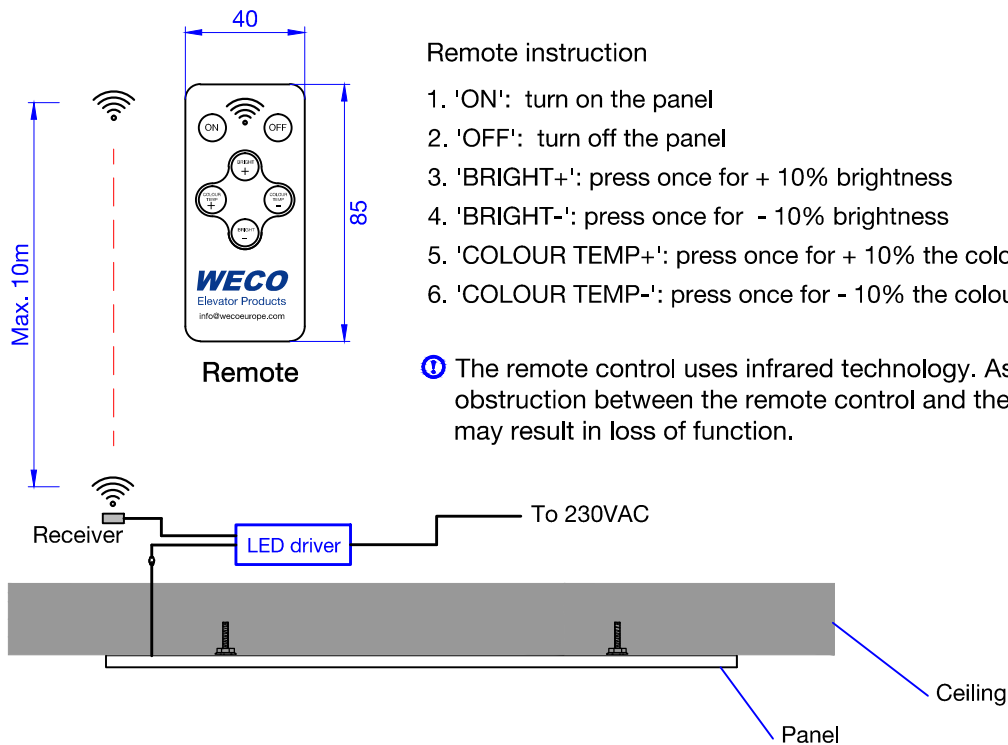

Remote instruction

1. 'ON': turn on the panel
2. 'OFF': turn off the panel
3. 'BRIGHT+': press once for + 10% brightness
4. 'BRIGHT-': press once for - 10% brightness
5. 'COLOUR TEMP+': press once for + 10% the colour temperature (K)
6. 'COLOUR TEMP-': press once for - 10% the colour temperature (K)

ⓘ The remote control uses infrared technology. As such, any obstruction between the remote control and the infrared receiver may result in loss of function.

Technical features

Power	Lumens	Input voltage	CCT
20W	1400 ~ 1700lm	100 ~ 240VAC	Adjustable from 3000 ~ 6000K